

Cut Sheet - PD30

1. Installation to be completed in accordance with manufacturer's written specifications and installation instructions.
2. See spec sheet or contact manufacturer for detailed material, finishes, and configuration options.
3. Contact manufacturer for detailed layout.
4. Do not scale drawings.
5. Subject to change without notice.

Available Materials

- | | |
|--|---|
| <input type="checkbox"/> Aluminum | <input type="checkbox"/> Galvalume® |
| <input type="checkbox"/> Copper | <input type="checkbox"/> Lead-Coated Copper |
| <input type="checkbox"/> Freedom Gray™ | <input type="checkbox"/> Rheinzink® |

Available Finishes

- | |
|---|
| <input type="checkbox"/> Mill Finish (Standard) |
| <input type="checkbox"/> Pre-Painted Aluminum
(Firestone UnaClad Kynar Color: _____) |
| <input type="checkbox"/> Powder Coated
(Tiger Drylac RAL# _____) |

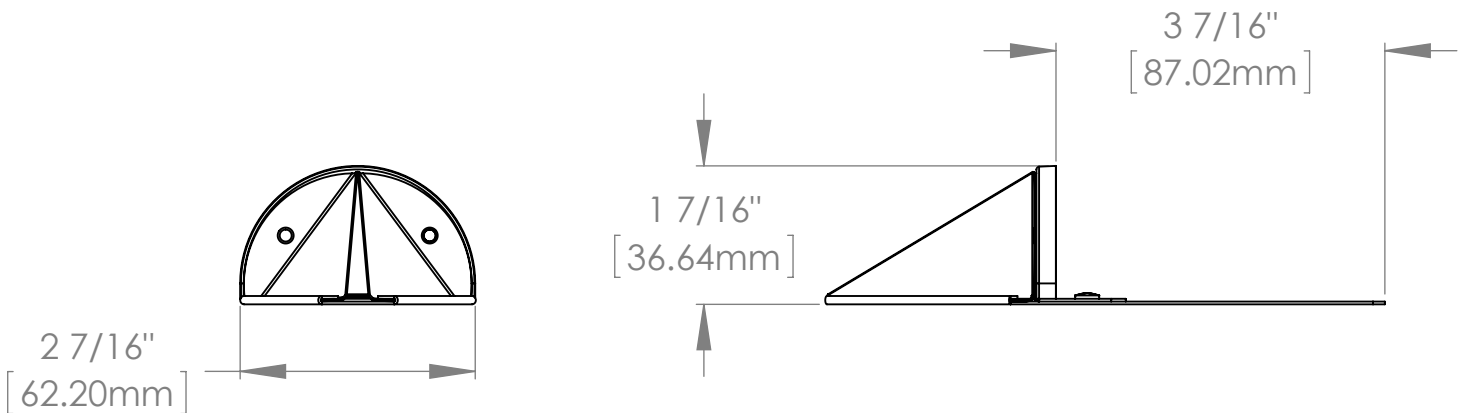
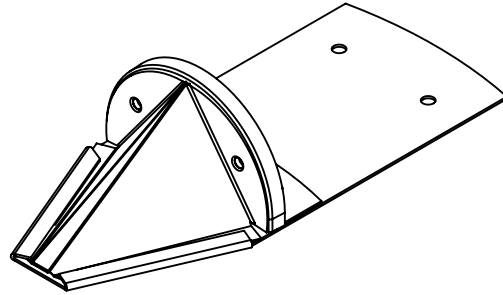
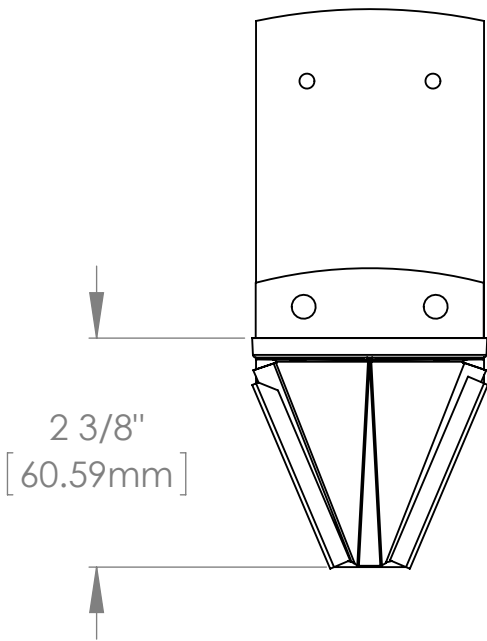

289 Harrel Street
Morrisville, VT 05661
Phone: 1.888.766.4273
Fax: 1.888.766.9994
Email: Info@alpinesnowguards.com

Scale: 1:2

4/25/2018