

Mullane Fitrite FR124ML, FR124BRZ, FR122 & FR121 Snow Fence Bracket for Two Pipes

Snow Rails for Slate Roofs with rafters less than 18 feet long

Installation Instructions:

Mullane Fit Rite rail products are available in **cast bronze (FR124BRZ, FR122)** and **galvanized malleable iron (FR124ML, FR121)**.

The technical information is for informational purposes only and is not intended to replace the manufacturer's recommendations for a particular project. We will provide layout layouts free of charge upon receipt of customer provided roof measurements. Manufacturer is not responsible for improper installation, or installation in insufficient quantities.

Every roof is not the same! Call today for a custom layout.

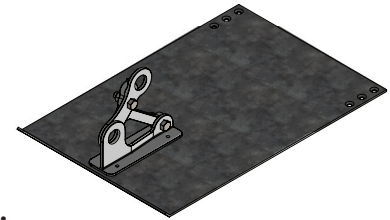

FR121

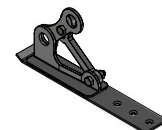

FR124ML

General Information:

Snow guards are devices that are attached to the roof structure in order to uniformly retain and hold snow in place on the roof area. The snow guards need to be applied in sufficient quantity according to a prescribed pattern in order to be effective. Snow Guards are intended to prevent snow movement and provide for the controlled melt and breakdown of the snow mass into smaller sections.

Snow guard placement will vary from region to region and will be influenced by roof pitch, the lengths of roof runs and roof features. Local installation customs may not be the best guide for placement. Additional information can be found in sheet metal and air conditioning contractors' national association (SMACNA) architectural sheet metal manual.

Berger Building Products, Inc. recommends that a qualified roofing contractor be employed to install these products. Roofing professionals have the proper equipment, knowledge and ability to complete the task in a safe and satisfactory manner. The applicator is responsible for compliance with regulations governing local building ordinances and safety regulations.

Safety Hazards

- Roofing can be hazardous! Serious injury or fatality can result from falls or electrocution from contacting overhead wires. Observe ladder safety rules for load, positioning and security.
- Please make sure all roof surfaces are dry and clean before working. Avoid working in excessive heat, high wind or when there is a threat of lightning. Never work alone.
- Do not allow material to be unsecured on the roof. Falling objects are dangerous.
- Prior to application, Berger Building Products, Inc. requires that the installer evaluate all products in order to determine fitness for use.

Do not use Competing/Dissimilar Metals with each other!

Galvanic corrosion will occur when dissimilar metals are in contact in the presence of an electrolyte. Water in the form of condensation, rain or snow is an electrolyte. Water that flows over copper becomes electronegative and will cause corrosion of aluminum or steel. Copper, brass or stainless steel fasteners or nails must be used with copper or brass applications. Make sure rivets are solid copper; do not use copper plated steel rivets in copper or brass assembly. Do not use aluminum or galvanized nails to secure any copper products. Corrosion will be more rapid in the presence of salts such as ocean coastal areas or chlorinated water, acid rain, and polluted industrial atmospheres. Accelerated corrosion will occur when a larger area of an electronegative (cathode/protected) element contacts a small electropositive (anodic/corroded) element.

Warranty/Disclaimer

Berger Building Products, Inc. (BBPI) warrants that the products it manufactures shall be free from material defects. Should any of the products prove defective, the obligation of BBPI under this warranty shall be limited to replacement of the defective product or at our option the cost of the product originally shipped by Berger. This warranty is expressly in lieu of all other warranties expressed or implied including the warranties of merchantability and fitness for a particular purpose. There are no warranties, which extend beyond the description on the face hereof. BBPI in no event, whether claim is based on warranties, contract negligence or otherwise, is liable for incidental or consequential damages.

Berger Building Products, Inc (BBPI) will not be responsible for misapplication or modification of product, incorrect material or defects that were obvious at time of installation. Any consequential damage, schedule delays, additional labor, and or equipment rental costs will not be BBPI responsibility. Any BBPI product warranty claim is limited solely to Berger Building Products, Inc.

Berger Building Products, Inc. (BBPI) reserves the right to change design and specification of our products without prior notification or alteration of literature. Materials may be revised to improve strength and corrosion properties and incorporated as a running change without obsolescence.

Installation of Mullane FR122/FR121 Snow Bracket on Slate or Synthetic Slate:

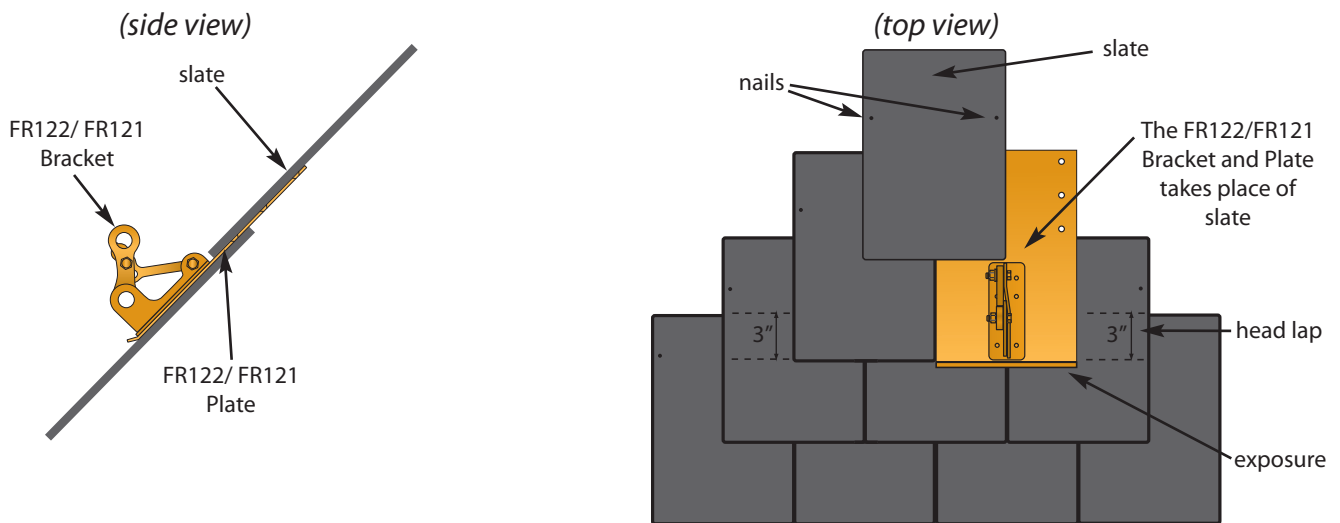

FR122/FR121 Snow Bracket Layout for Slate or Synthetic Slate Roofs:

Every guard will not fit every roofing application. It is important to know the size and thickness of your slate or synthetic slate prior to selecting a snow guard.

1. Install snow fence bracket parallel to the eaves, spacing the brackets from 24" to no more than 36" apart, depending upon the pitch of the roof and the anticipated snow load. Install brackets approximately 24" to 36" from the roof edge.
2. **FR121 & FR122** have a base plate than matches the size of the slate. **FR124ML & FR1242BRZ** come with a stock base plate of 2" x 12".
3. Recommended installation method is to use through Bolts, with a backer plate on the underside of the sheathing. However, this is not always a viable option. **FR122 & FR121** secure fasteners through each pre-drilled hole (6). **FR124ML & FR122BRZ** secure fasteners through each pre-drilled holes (3). *Note: installing the FR124MI/FR124BRZ models on slate roofing may require notching for proper fit, but are ideal for use on shingle roofing. See instructions on page 4.*
4. Tubing: Models: **FR124BRZ & FR122** - the use of (0.50" ID) bronze, red brass or stainless steel pipe is recommended. Copper water pipe is not recommended as the force of snow can cause this pipe to bend, which could transfer twisting, lateral forces to the bracket, with the possibility of system failure. Models: **FR124ML & FR121** - The use of (0.50" ID) galvanized tubing is recommended.
5. In high snow load areas, or rafters over 18', use of a 3-rail product, either a Mullane 500 or a **Fitrite 131/132** is recommended.
6. Snow guards should never be placed beyond the bearing wall on an extended roof section. This can result in ice damming and cause structural damage.
7. Every roof is different, call today for your free layout recommendation.

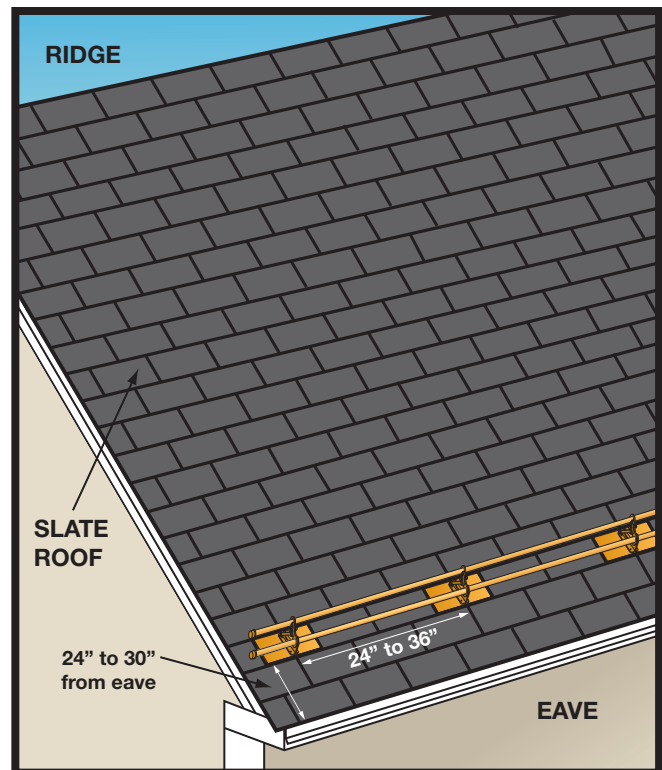

The patterns shown are typical for a rafter run of no more than 20 feet in an area with a ground snow load no more than 30 psf. If your project exceeds this criteria, contact Berger for a free consultation.

Positioning of the Mullane FR122/FR121 Snow Bracket Assembly on Slate Roofs:

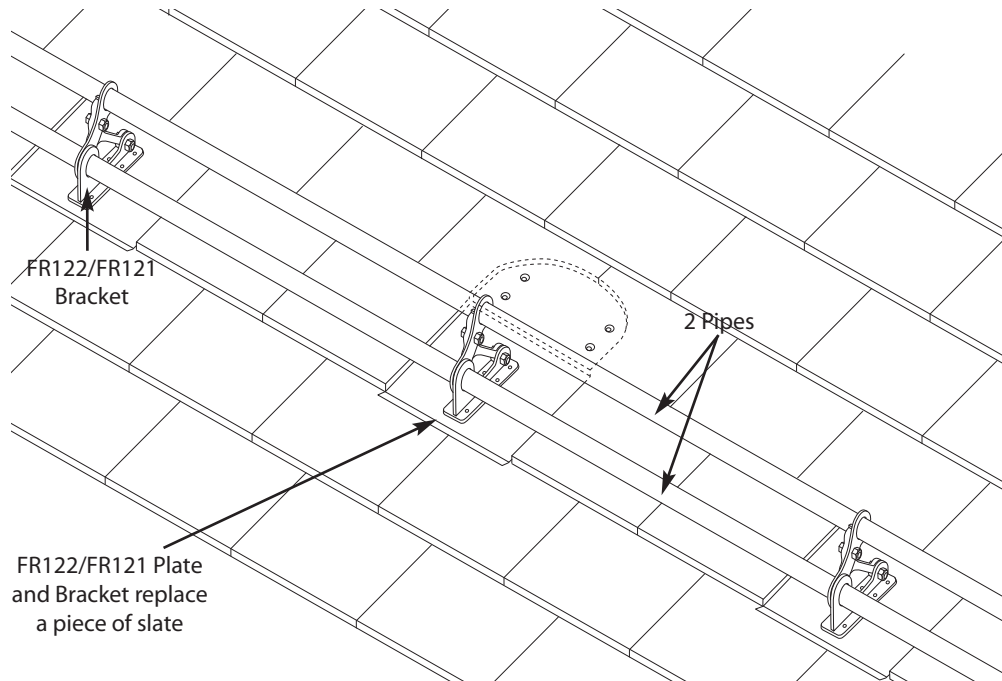

Typical FR122/FR121 spacing on 1/4" (.025") thick slate.
For illustration purposes only, drawing not to scale

Installation of the Mullane FR124ML/FR124BRZ Snow Guard on Asphalt Singles

(top view)

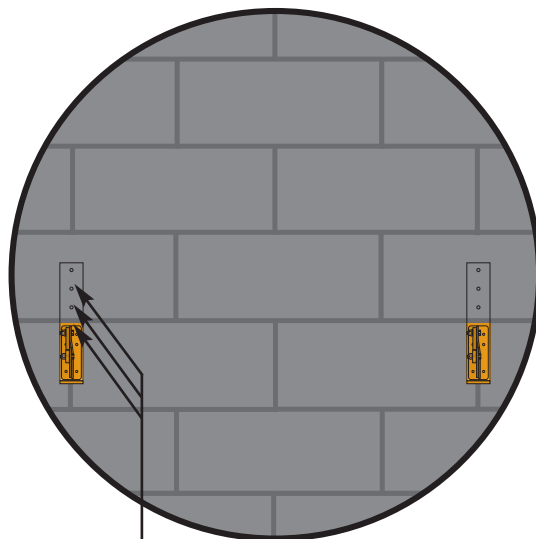

Nail Snow Guard here to secure to the roof.

Installation of the Mullane FR124ML/FR124BRZ Snow Guard on Asphalt Singles:

1. Install snow fence bracket parallel to the eaves, spacing the brackets from 24" to no more than 36" apart, depending upon the pitch of the roof and the anticipated snow load. Install brackets approximately 24" to 36" from the roof edge.
2. **FR124ML & FR124BRZ** come with a stock base plate of 2" x 12".
3. Recommended installation method is to use through Bolts, with a backer plate on the underside of the sheathing. However, this is not always a viable option. **FR124ML & FR124BRZ** secure fasteners through each pre-drilled holes (3).
4. Tubing: Models: **FR124BRZ** - use of (0.50" ID) bronze, red brass or stainless steel pipe is recommended. Copper water pipe is not recommended as the force of snow can cause this pipe to bend, which could transfer twisting, lateral forces to the bracket, with the possibility of system failure. Models: **FR124ML** - use of (0.50" ID) galvanized tubing is recommended.
5. Snow guards should never be placed beyond the bearing wall on an extended roof section. This can result in ice damming and cause structural damage.
6. Every roof is different, call today for your free layout recommendation.

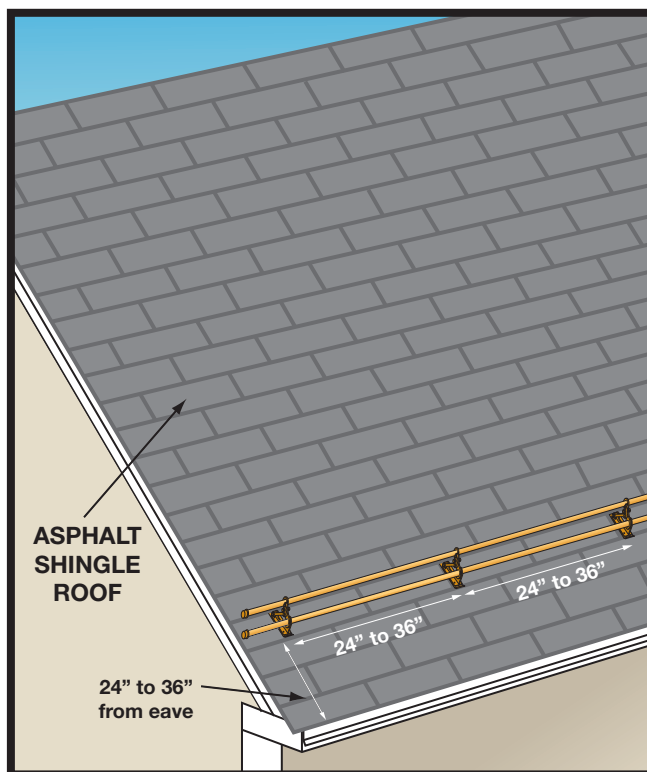

The patterns shown are typical for a rafter run of no more than 25 feet in an area with a ground snow load no more than 30 psf. If your project exceeds this criteria, contact Berger for a free consultation.