

# PRODUCT SPECIFICATION

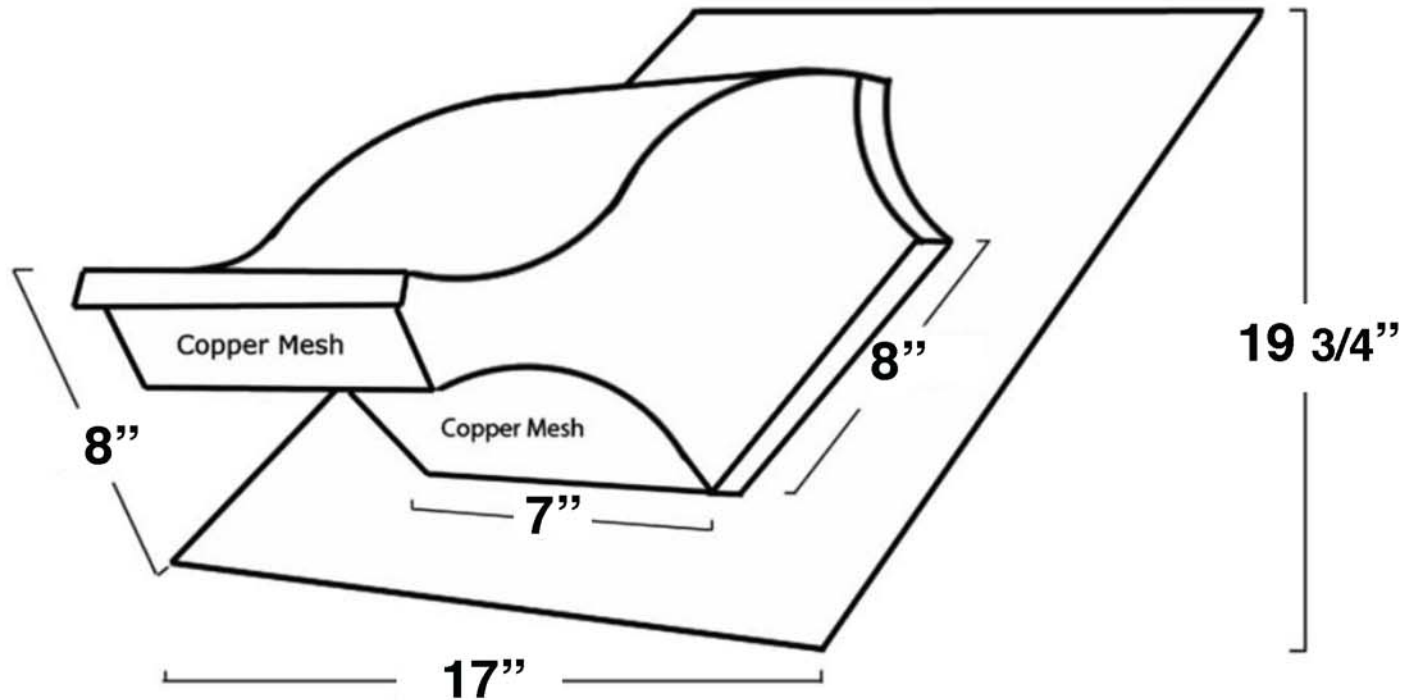

Sold at:  
**SlateRoofWarehouse.com**  
Ph: 814-786-9085  
mail@josephjenkins.com

## **SALVO METAL WORKS VENT #501**



### **FINISHES**

COPPER  
LEAD COATED COPPER  
COPPER COATED STAINLESS  
FREEDOM GREY  
ZINC

All Salvo Metal Works copper vents are beautifully handcrafted in house by a world class sheet metal team with soldered or riveted joints . They are available in a variety of finishes but are typically made from 16 ounce copper. Shown are stock designs that can be customized. Please allow 1 - 2 weeks lead time for orders.